

TABLE OF CONTENTS

About Us	2
Conditions of Sale and General Information	3
Warranties	4
Furniture Care and Cleaning	5
Fabric Applications	5
Fabric and Trim Cut Yardage	6
Leather Cut Footage	6
Contrast Fabric / Leather Parts	7
Contrast Throw Pillows	7
Frame Parts Diagram	7
Nail Trim Options	8
Headboard Nail Trim Options	8
Finish Options	9
Decorative Stitching Options	9
Skirt Options	9
Caster and Ferrule Options	10
Loose or Semi-Attached Back Cushion Options	10
Cushion Fill Options	11
Trim and Embroidery Options	12
Headboard and Bed Components	13
Bed Support Assembly Instructions	13
Sleeper Mattress Options	14
Custom Length	14
Cushion Configuration Options	14
Slipcover Only Pricing	15
Arm Covers	15
Cartoning	15
COM Information Form	16
COM Guidelines	17
Pillow Treatments	18
Leather Throw Pillows by Leather Grade	18
Throw Pillow Prices by Fabric Grade	19-20
Style Prices by Numerical Style Number	21-158
Headboard / Bed Prices	159-166
Custom Design - 8600 Series	167-176
Custom Design - 8700 Series	177-186
Custom Design - 8800 Series	187-193
Alphabetical Index by Style Name	194-199
Alphabetical Index for Beds & Headboards by Style Name.....	200

ABOUT US

Mission Statement We create inspiring upholstered furniture through innovative STYLE. COMFORT. and COLOR.

Vision Statement Passion to be the best in every area of our business drives our continued while sustainable growth. Our core focus is on our people, processes, and product. Outstanding customer service supports our network of retailers and designers. Cutting edge technology joins handmade craftsmanship in an environment that supports our local vendors and community. We are stewards of our craft and our environment as we bring innovative, desirable American-made custom upholstery to homes across America and abroad.

Environmental Statement We are committed to preserving the resources of our world for future generations. It is our goal to minimize the environmental impacts of our company through the continual improvement of waste reduction and the use of sustainable practices.

Sustainable Story Our frames are made from sustainably harvested hardwoods from the Appalachian mountain of the USA. A recent analysis by the USDA found our supplier's intensive forestry management has provided the region with a consistent increase in hardwood growth for the past 50+ years. This means your purchase has not and will not compromise the lumber needs of future generations.

We strive to minimize the environmental impacts of our facility through waste reduction and energy conservation. We carefully track our use of wood, foam, fabric, water, paper, batteries, cardboard, and aluminum to minimize waste and to maximize our recycling.

Construction Our North Carolina artisans have created the best in customized, bench-crafted upholstery since 1958. We utilize new processes and equipment while holding true to time-tested premium construction features.

Frames are made using 5/4" or thicker kiln-dried select hardwoods or engineered hardwoods from verified sustainable forests. Joints are double-doweled, glued, screwed and blocked on every corner or mortise and tenon construction for rigidity and strength.

Non-absorbent, odor-free polypropylene sheeting and steel strapping provide lasting support for rows of double-cone coil springs. Made from recycled steel, these springs are clinched to prevent shifting, then interlaced and hand-tied with fine twine in eight directions. Due to construction requirements, some pieces will have either sinuous springs or webbed-based construction.

All foam incorporates HR (High resiliency – 1.8 minimum density) BiOH polyols derived from natural, renewable soy beans. When compared to traditional petroleum based polyols, BiOH requires less non-renewable energy to manufacture, emits less global warming emissions, and reduces the industry consumption of petroleum. We offer a variety of seat and back cushion options with varying levels of support. Refer to the price list for both the style-specific standard seat/back cushion fill as well as charges for changing the standard seat/back cushion fill.

Artisans build your upholstery piece one at a time aligning fabric patterns from top-to-bottom and side-to-side with seamless continuity. Because each piece is individually crafted on a custom order basis, the dimensions listed are approximate and can vary due to fabric, internal filling, as well as the individual craftspeople involved with its manufacturing.

Styles featuring exposed wood can be customized using our selection of hand-applied finishes including any Benjamin Moore paint color.

CONDITIONS OF SALE and GENERAL INFORMATION

- Information Required**
- Purchase Order Number and Date
 - Quantity
 - Product Number and Description
 - Fabric Pattern Name and Color
 - Finish Selection
 - Cushion Selection
 - Any optional fringe, cord, decorative treatments, etc.
 - Complete Billing Address
 - Complete Shipping Address
 - Complete Shipping Instructions and Carrier
 - Telephone and Fax Number

All orders or correspondence should be mailed, faxed, or emailed to:

Mailing Address:

PO Box 2128
Hickory, NC 28603

Phone 828.328.1831

Fax 828.328.4523

Physical Address:

2829 Highway 70 SE
Hickory, NC 28602

E-mail: orders@crlaine.com

Terms Net 30 days - FOB Factory

Sales Aids Sales materials including swatches, binders, catalogs, and price lists remain our property. We reserve the right to reclaim these at any time.

Acknowledgements A copy of each acknowledged order will be e-mailed or faxed to the retailer. This acknowledgement should be checked immediately for accuracy. In the event of an error, contact our customer service as soon as possible; otherwise, the order will be considered correct, and the merchandise will be built and shipped as acknowledged.

Cancellations Cancellation requests must be in writing. We cannot accept responsibility for verbal cancellations. Because each piece is individually crafted on a custom order basis, we cannot honor a cancellation request once the order has been entered into production. Orders for cut yardage cannot be cancelled after the yardage is ordered.

Delivery/Shipping All delivery dates are approximate and subject to conditions beyond our control.

- Sold orders will ship complete, unless otherwise requested.
- Stock orders will ship as ready, unless otherwise requested.

Prepaid Freight Prepaid freight requests will be charged a \$20 handling fee.
All UPS shipments will be charged a \$10 handling fee.

Returns We will repair and return pieces that have been found to be defective per our warranty guidelines. Factory authorization must be obtained prior to any return. We will be responsible for authorized repair charges and will return pieces free astray with the original freight carrier.

Deluxing, Touch-up, and Minor Repairs Occasionally, upholstery pieces will need deluxing (steaming, cushion fluffing, etc.), touch-up, and minor repairs when received. Retailers are to provide these services without reimbursement from us as part of the retailer's normal service obligation.

Local Repairs Charges for a local repair will not be accepted without prior factory authorization.

Transit Damage Pieces should be carefully inspected upon delivery, and any visible damage noted on the Bill of Lading (BOL). A claim for transit damage (visible or concealed) must be filed by the retailer with the freight carrier within 10 days.

UFAC All of our upholstery pieces meet the Upholstery Furniture Action Council (UFAC) specifications.

WARRANTIES

Warranty Requirements Warranty periods listed below begin at the date of invoice from us to our retailer and are extended only to the original owner/purchaser. The purchaser should report service issues to the retailer from which the product was purchased. The retailer will contact us regarding service arrangements. If service is necessary and cannot be provided locally, the product will be returned to our factory. The retailer will be responsible for any wrapping and cartoning fees incurred for the product return. After service has been completed, the product will be returned to the retailer free astray with the original freight carrier. The retailer will provide transportation between the customer and the retailer without reimbursement from us as part of the retailer's normal service obligation. The purchaser has specific legal rights under this warranty and may have other rights which vary from state to state.

Dimensions Each piece is individually crafted on a custom order basis. It is for this reason that the dimensions listed are approximate and can vary due to fabric, internal filling, as well as the individual craftspeople involved with its manufacturing. We reserve the right to make minor construction or design changes for product improvement.

Frame Frames are made using 5/4" or thicker kiln-dried select hardwoods or engineered hardwoods from verified sustainable forests. Joints are double-doweled, glued, screwed, and blocked on every corner or mortise and tenon construction for rigidity and strength. Each piece is designed and gauged to withstand everyday household usage. All frame components (excluding legs) are warranted against defective material and workmanship for life to the original owner/purchaser.

Suspension Non-absorbent, odor-free polypropylene sheeting and steel strapping provide lasting support for the double-cone coil springs. Made from recycled steel, these springs are clinched to prevent shifting, then interlaced and hand-tied with fine twine in eight directions. The bed of suspended coils is covered with the appropriate materials for each piece including a special deck padding made using regenerated fiber and soft batting. All components of the suspension are warranted against defective material and workmanship for life to the original owner/purchaser.

Back / Seat Cushions Cushions are warranted to remain resilient and free from manufacturing defects for five (5) years beginning at the date of invoice from us to our retailer. Loss of resiliency should not be confused with softening. Under normal household use, cushions will soften and conform to the user's shape and become more comfortable. Softening is not covered by the warranty. Proper maintenance including frequent seat and back rotation will provide longer life and greater durability.

Sleeper Mattress All components of our standard Kingsdown® sleeper mattress are warranted against defective material and workmanship for five (5) years beginning at the date of invoice from us to our retailer.

Air Dream Mattress The mattress, air bladder, and air bladder valve are warranted for three (3) years, and the pump for one (1) year against defective material and workmanship beginning at the date of invoice from us to our retailer.

Motion Mechanisms Sleeper bed units, swivels, swivel gliders, and swivel rockers are warranted against defective material and workmanship for three (3) years beginning at the date of invoice from us to our retailer.

Fabric The warranty for fabrics (including slipcovers) relies upon the warranty from the fabric mill in regards to quality, color fastness, and/or durability. Any service arrangements are at the discretion of the fabric mill. This warranty does not cover fading, pilling, or shrinkage, and is not valid where there is evidence of heavy soiling. All fabric warranties are null and void if improperly cleaned or treated with a chemical fabric treatment.

FABRIC CARE AND CLEANING

FABRIC APPLICATIONS

Furniture Care Loose back cushions and seat cushions should be reversed and fluffed regularly to prevent settling of cushion fills, excessive wrinkling, and insure proper fabric wear. Never place your upholstery in direct sunlight, as this will subject the fabric to fading. We cannot guarantee the wearing qualities nor colorfastness of any fabric.

Cleaning Codes Code S: To spot clean, use a mild, water-free solvent or dry cleaning product. Clean only in a well-ventilated room, and avoid any product containing carbon tetrachloride or other toxic material. The use of steam or water-based cleaners may cause excessive shrinking and staining of this fabric. Pre-test a small area before proceeding.

Code SW: To spot clean, use a WATER-BASED cleaning agent or a mild, water-free solvent or dry cleaning product. Use solvents only in a well-ventilated room, and avoid any products containing carbon tetrachloride or other toxic material. Pre-test a small area before proceeding.

Code W: To spot clean, use the foam only from a WATER-BASED cleaning agent such as a mild detergent or non-solvent upholstery shampoo product. Apply foam with a soft brush in a circular motion. Vacuum when dry. Pre-test a small area before proceeding.

Code X: DO NOT use foam or liquid cleaning agents of any type.

Cleaning Guidelines The fabric mill has suggested the above fabric-specific cleaning methods. We suggest pre-testing in an inconspicuous corner to insure color fastness. Additionally, we heartily recommend that the article be cleaned by a reputable, professional cleaner. In no way will we assume any responsibility for the method of cleaning our fabric. While provided for assistance in the general cleaning and maintenance of your upholstery fabric, these guidelines are in no way meant to imply that fabrics cannot be soiled or worn beyond repair. If you have questions after reading these guidelines, contact our customer service for more information.

Fabric Application Patterned upholstery fabrics will have what we have determined to be the main focal point centered on the back cushions and on the seat cushions. When applicable, the pattern will flow from the seat cushion down the seat cushion boxing, the seat front, and onto the skirt.

Fabrics are either cut "railroad" or "regular/up the bolt" depending upon the direction of the pattern. The illustrations below further explain these terms. Fabrics that are not "railroaded" will require seaming when applied to long cushions and tight backs. If possible, we cut fabrics "railroaded" to avoid these seams. But, if not possible, we will position the necessary seams at our discretion.

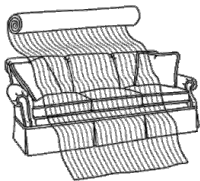

**Regular Application
(Up The Bolt)**

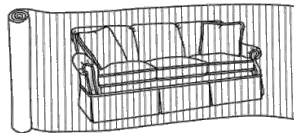

Railroad Application

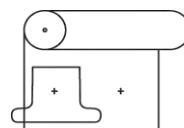

Chair Cushion

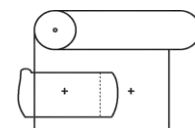

Sofa Cushion

Two cushion sofas may be off-centered slightly to avoid seaming of cushions and back pillows.

CUT YARDAGE

Fabric Stain Guard Due to warranty issues, we no longer offer stain guard protection.

Fabric Cut Yardage The minimum order for cut yardage is one yard. Afterwards, you may purchase in 1/2 yard increments. If you want cut yardage shipped somewhere other than your normal delivery address, be sure to include the complete physical address. UPS shipping charge and our UPS handling fee will be added.

Grade	Price Per Yd	Grade	Price Per Yd
5	\$36	17	\$96
6	\$38	18	\$102
7	\$40	19	\$108
8	\$44	20	\$114
9	\$48	21	\$120
10	\$54	22	\$126
11	\$60	23	\$132
12	\$66	24	\$136
13	\$72	25	\$140
14	\$78	26	\$144
15	\$84	27	\$148
16	\$90	28	\$152

*Cut yardage amounts less than five yards may not be returned for credit. A 20% restocking fee will be charged for returns of over five yards.

Trim Cut Yardage

	Price Per Yd		Price Per Yd
Cord	\$14	Fringe Woolly	\$28
Band Crewel	\$38	Gimp	\$22
Band 1.5"	\$28	Nail Tape	\$6
Band Dot	\$28	Tassel	\$42
Band Fret, Key, and Logo	\$30	Tassel 3"	\$28
Fringe	\$20		

Leather Cut Footage

Must order whole hides.

Contact customer service

for sizes in stock.

Grade	Price Per Sq Ft
7	\$14
8	\$15
9	\$16
10	\$17
11	\$17
12	\$18

CONTRAST FABRIC / LEATHER PARTS CONTRAST THROW PILLOWS FRAME PARTS DIAGRAM

Fabric Combinations If a combination of fabric is used anywhere on a frame except the bolster, throw pillows, and welt, the price will be determined by the **highest grade** of the fabric or leather selected. If four or more contrasting options are requested, then add **\$300** to the price.

	Contrast Welt and/or Skirt Block	Contrast Bias Welt	Contrast Leather Welt on Leather Styles	Contrast Welt with BRISA
Contrast Welt, Skirt Block				
Sofa/Sleepers/Daybed	\$60	\$90	\$90	\$270
Loveseat/Chair & Half/Chaise/Settee/Headboard	\$50	\$70	\$70	\$240
Chair/Dining Chair	\$40	\$60	\$60	\$160
Ottoman	\$30	\$40	\$40	\$140

Contrast Throw Pillows			
Fabric Grades 5-18 & COM	\$24	each	
Fabric Grades 19-23	\$50	each	
Fabric Grades 24 and up	\$70	each	<i>(excluding BRISA & Specialty Pillows)</i>
Fabric Welt (any grade)	\$10	each	
Leather (any grade)	\$120	each	
Leather Welt (any grade)	\$42	each	

	Seat	Tight Seat	Seat Border	In Back	Out Back	Welt-All
Contrast Leather Parts						
Sofa/Sleepers/Daybed	\$130	\$260	\$90	\$240	\$240	\$270
Loveseat/Chair & Half/Chaise/Settee/Headboard	\$110	\$210	\$80	\$190	\$190	\$240
Chair/Dining Chair	\$90	\$150	\$70	\$120	\$120	\$160
Ottoman	\$130	\$150	\$90	n/a	n/a	\$140

	In Arms	Arm Panels	Out Arms	In Wings	Out Wings
Per Pair	\$320	\$70	\$160	\$90	\$90

Note: Contact customer service to quote contrast leather seat cushion and/or back cushion.

Frame Parts Diagram

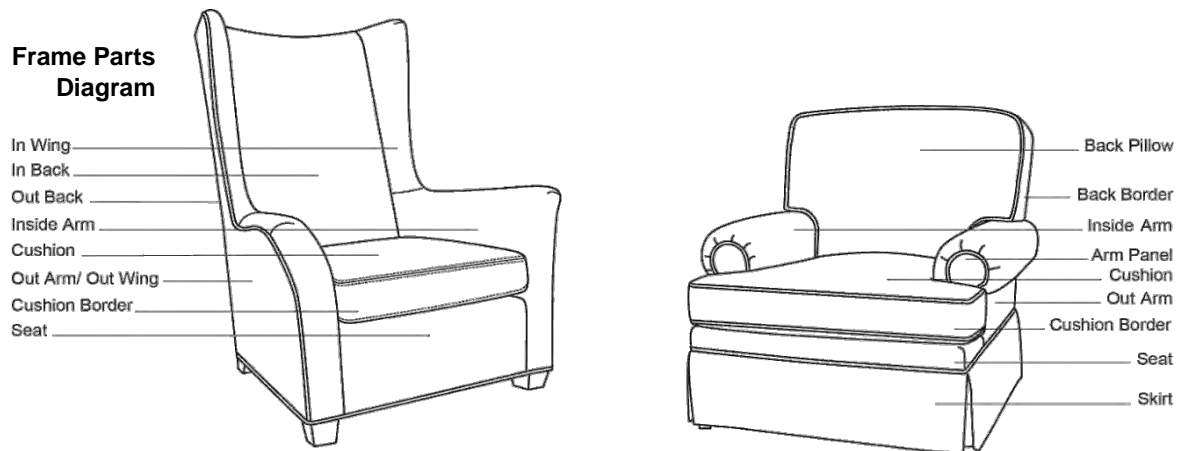

NAIL TRIM OPTIONS HEADBOARD NAIL TRIM OPTIONS

Nail Trim Nail trim is available on most styles. The placement varies to enhance each style. If you have a specific placement or spacing in mind, enclose a detailed description or drawing with your order. Styles standard with nail trim can be ordered without it at no additional cost, **except for the 5190 series, 617-07, 810-05, and 811-05.**

Specify "no nails" on your order, if applicable.

Note: Nail trim is not available on the front of sock arms nor front and top of track arms.

Medium Nail Colors Antique, Brass, Chrome, Bronze, Pewter, Burnished, Black Nickel

Small Nail Colors Antique, Brass, Chrome, Bronze, Pewter, Burnished, Black Nickel

	Decorative Nails	Cut Tack Nails
Sofa/Sleeper/Daybed	\$170	Call Customer Service
Loveseat/Chair & Half/ Chaise/Settee	\$150	
Chair/Dining Chair	\$130	
Ottoman	\$80	

Nail Tape Trim Nail tape trims are 5/8" wide and can only be used with small nail trim. See catalog for nailhead tape trim colors.

Fabric Nail Gimp Fabric nail gimp can only be applied to the base.

	Nail Tape	Fabric Gimp
Sofa/Sleeper/Daybed	\$100	\$110
Loveseat/Chair & Half/ Chaise/Settee/ Headboard	\$80	\$90
Chair/Dining Chair	\$50	\$70
Ottoman	\$30	\$70

Nail Spacing Examples

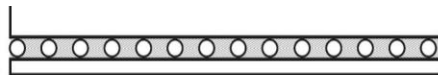

Nail Tape with Small Nails Spaced 1:1



Fabric Gimp with Medium Nails spaced 2:1

**Headboard
Nail Trim Options**

100, 200, 300, 400 Series Only

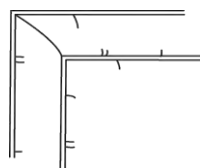

Welt Only

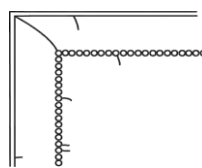

Nails Inside

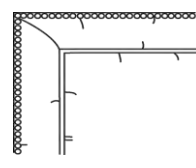

Nails Edge

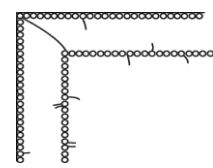

Two Rows

Nail trim charge for one row	\$150
Additional charge for 2nd row	\$100

FINISH OPTIONS DECORATIVE STITCHING OPTIONS SKIRT OPTIONS

Finish Options Fruitwood is **standard**. Refer to individual styles for premium finish upcharge.

<u>No Charge</u>	<u>Premium</u>	<u>Metal Frame Finishes</u>
Dune	Aged	Gold
Fruitwood (standard)	Driftwood	Slate
Greystone	English Antique	
Honey Pine	French Antique	
Java	Graphite	
Mahogany	Tavern Black	
Pepper	Benjamin Moore Paint Colors**	
Sable	**only available in	
Salt	our standard sheen	
Teddy Bear	with laquer top coat	
Walnut		

**We do not send samples of Benjamin Moore paint colors. Visit your local Benjamin Moore retailer for color samples. Due to the natural characteristics of wood, finishes will vary from sample chips.

Decorative Stitching Options Decorative stitching can replace welt at sewn areas, i.e. seat and back cushions, and throw pillows. If the style has either sock arms, track arms, or welted tight back, the stitching option chosen will replace welt in **all** areas, unless otherwise specified.

	Saddle-Stitch	French Seam	French Seam Rope Stitch
Sofa/Sleepers/Daybed	\$170	\$170	\$200
Loveseat/Chair & Half/Chaise/Settee/ Headboard	\$120	\$120	\$150
Chair/Dining Chair	\$60	\$60	\$80
Ottoman	\$40	\$40	\$60
Extra Throw Pillow	\$26	\$26	\$30

Examples:

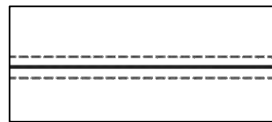

Saddle-Stitch

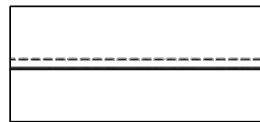

French Seam

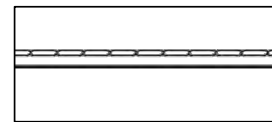

French Seam Rope Stitch

Note: See catalog or website for available colors

Skirt Options and Contrast Skirt Band It is noted in the price list with the individual style if the piece is standard with a skirt. Skirt options listed below can be interchanged \$90.

Kick Pleat Closed Box Pleats
Ruffled Kick Pleat/Ruffled Corners (front corners only)

Note: Draped skirts can not be interchanged nor decorative cord added.

Note: Skirts cannot be added to barrel styles.

Note: Refer to our catalog for Skirt Options and Contrast Skirt Band Application diagrams.

Note: Velvets are not recommended for contrast fabric skirt bands.

	Add Skirt to Style	Contrast Fabric Skirt Band	
Sofa/Sleepers/Daybed	\$280	\$160	<i>applied at hem only</i>
Loveseat/Chair & Half/ Chaise/Settee/ Headboard	\$230	\$120	<i>2" is standard 1" and 4" also available</i>
Chair/Dining Chair	\$120	\$90	
Ottoman	\$120	\$90	

CASTER AND FERRULE OPTIONS LOOSE OR SEMI-ATTACHED BACK CUSHION OPTIONS

Casters Hooded ball casters are available at **\$15.00 each**. These are recommended for mobility purposes. The same seat height is maintained when hooded casters are used.



Decorative Caster Decorative casters are standard on some items and indicated with each style in the catalog.
Finishes Antique brass is standard, unless brushed nickel is specified. However, when combined with nail trim, brushed nickel casters will be used when chrome or pewter nails are chosen.

Substitute Ferrules The styles below are standard with stem casters. Stem ferrules can be substituted at no charge upon request.

Style	Stem Caster	Stem Ferrule
34		
44		
235		
1804		
1805		
2000		
2004		
2426		
2428		
5556		
8530 Series		
CD8800 Series (turned leg with casters)		

These styles are standard with cup casters. Cup ferrules can be substituted at no charge upon request.

Style	Cup Caster	Cup Ferrule
39		
56		
8195, 8197		
9125, 9127		
9126-05, 9126-07		

NO SUBSTITUTES ARE AVAILABLE FOR THESE STYLES WITH STANDARD CASTERS

Style	
54	
55	
3800 Series	(can substitute a taller tapered leg)
8430 Series	
9000 Series	
9001 Series	
CD8800 Series	(tapered leg with casters)

Loose Back Cushion Option Semi-attached back cushion styles can be ordered with optional loose back cushions for an additional charge of : **Sofa \$225 Loveseat \$150 Chair \$75**

Note: Loose backs cushion styles cannot be ordered as semi-attached.

CUSHION FILL OPTIONS

Seat Cushion Options **Standard Seat Cushion Fill:** Refer to the individual style in the price list for both the style-specific standard seat cushion fill as well as charges for changing the standard seat cushion fill.

Slipcovered Ottoman Top Fill: Due to slipcover ottoman construction, optional fill for cushion tops are not available.

Committed to environmental stewardship, all foam incorporates BiOH HR (High resiliency – 1.8 minimum density) polyols derived from natural, renewable soy beans. When compared to traditional petroleum based polyols, BiOH requires less non-renewable energy to manufacture, emits less global warming emissions, and reduces the industry consumption of petroleum. We offer six seat cushion fill options with varying levels of support. Refer to the individual style in the price list for both the style-specific standard seat cushion fill as well as charges for changing the standard seat cushion fill.

California Requirements: We use flame-retardant-free cushions, foam, and decking that has been tested and approved by CertiPUR-US® to meet standards for content, emissions, and durability to ensure consumer safety and environmental stewardship. Per this new regulation, and effective January 1, 2015, all of our products are now labeled as CA TB117-2013 compliant. Learn more at <http://certipur.us/>

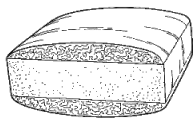

Hallmark Seat Cushion (Medium Firmness)

BiOH HR (high resiliency – 1.8 minimum density) foam core (10% soy) is wrapped in polyester fiber then encased in ticking. This cushion will have a tailored look with good recovery. For additional seating support, **Extra Firm Hallmark** is available at no charge.

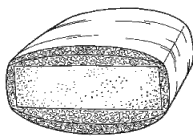

Extra Firm Hallmark Seat Cushion (Very Supportive Feel)

Hallmark Seat Cushion construction with a firmer, higher compression poly foam core.

Mayfair Seat Cushion (Soft Feel)

BiOH HR foam core is double wrapped in polyester fiber then encased in a down proof ticking. This cushion will have comfort wrinkles due to its softer construction.

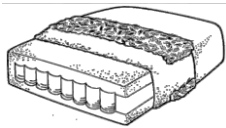

Hamilton Spring Down Seat Cushion (Medium Firmness)

Individually wrapped coil springs are enclosed in BiOH HR foam. This core unit is then wrapped in polyester fiber, then covered in a blend of polyester fiber, and feathers and down which have been sewn into a channeled down proof ticking.

Comfort Down Package (Soft Feel)

This package is:

Comfort Down Seat Cushion: BiOH HR foam core with a soft foam wrap is covered in a blend of polyester fiber, and feathers and down which have been sewn into a channeled down proof ticking. This cushion will have a soft and casual feel.

Comfort Down Back Cushion: 25% down and feathers is combined with 75% polyester fiber and then sewn into a channeled down proof ticking.

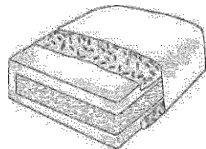

Plush Down Package (Super Soft Feel)

This package is:

Plush Down Seat Cushion: BiOH HR foam core with soft foam toppers is wrapped with a layer of polyester fiber, and then covered in a generous amount of a 10% down and 90% feather blend which has been sewn into a channeled down proof ticking. This cushion will be super soft with a relaxed look and casual feel.

Legacy Down Back Cushion: 50% down and feathers blended with 50% polyester fiber is sewn into a channeled down proof ticking.

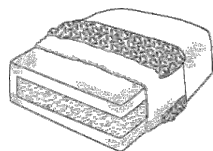

Back Cushion Options **Standard Back Cushion Fill:** Refer to the individual style in the price list for both the style-specific standard back cushion fill as well as charges for changing the standard back cushion fill.

Fiber Back Cushion: Polyester fiber is sewn into a channeled ticking.

Extra Full Fiber Back Cushion: Only available on semi-attached or loose back cushion styles that are standard with a Fiber Back Cushion or a Comfort Down Back Cushion.

Comfort Down Back: 25% down and feathers is combined with 75% polyester fiber and then sewn into a channeled down proof ticking.

Legacy Down Back: 50% down and feathers is combined with 50% polyester fiber and then sewn into a channeled down proof ticking. **Refer to pg 255 in our catalog for further details**

Throw Pillow Options **Legacy Down TP Fill:** 5% down and 95% feathers is sewn into a down proof ticking. Legacy Down is the standard pillow fill for all styles that feature throw pillows as well as all extra pillows ordered.

Fiber TP Fill: Polyester fiber throw pillow fill is available upon request at no extra charge.

TRIM AND EMBROIDERY OPTIONS

			Sofa/ Sleeper/ Bed/ Davbed	Loveseat Chair & Half Chaise/Settee/ Headboards	Chair/ Dining Chair	Ottoman
Trim Options						
BAND	Band Crewel	Back Pillows	\$300	\$200	\$100	n/a
		Skirt or Base	\$240	\$190	\$140	\$140
	Band Dot	Skirt or Base	\$120	\$100	\$80	\$80
		Back Pillows	\$150	\$100	\$50	n/a
	Band Fret, Key, Logo	Back Pillows	\$240	\$160	\$80	n/a
		Skirt or Base	\$200	\$160	\$120	\$120
BAND	Band 1.5"	Back Pillows	\$150	\$100	\$50	n/a
		Skirt or Base	\$120	\$100	\$80	\$80
<i>Decorative bands cannot be applied on top of velvet fabrics.</i>						
CORD	Cord	Back Pillows	\$100	\$70	\$50	n/a
		Seat Cushions	\$120	\$90	\$60	\$50
		Skirt or Base	\$80	\$60	\$50	\$36
		Body	\$90	\$70	\$50	\$36
FRINGE	Fringe	Back Pillows	\$160	\$110	\$60	n/a
		Seat Cushions	\$160	\$110	\$70	\$60
		Skirt or Base	\$90	\$70	\$50	\$50
		Body	\$100	\$80	\$60	\$40
FRINGE	Fringe Wooly	Back Pillows	\$300	\$220	\$110	n/a
		Seat Cushions	\$300	\$220	\$110	\$100
		Skirt or Base	\$130	\$110	\$90	\$80
		Body	\$130	\$110	\$90	n/a
GIMP	Gimp	Skirt or Base	\$120	\$100	\$80	\$80
MINI RUFFLE	Mini Ruffle 3/4"	Cushions / Back / TP	\$160	\$110	\$60	\$40
TASSEL	Tassel	Skirt or Base	\$280	\$230	\$180	\$160
	Tassel 3"	Skirt or Base	\$130	\$110	\$90	\$80
WELT	Bias Welt	All Over	\$90	\$70	\$60	\$40
	Contrast Welt	All Over	\$60	\$50	\$40	\$30
	Contrast Bias Welt	All Over	\$90	\$70	\$60	\$40
	Decorative Band Welt with Band 1.5"	Back Pillows	\$100	\$70	\$50	n/a
		Seat Cushions	\$120	\$90	\$60	\$50
		Skirt or Base	\$80	\$60	\$50	\$36
		Body	\$90	\$70	\$50	\$36
	Flat Welt	All Over	\$160	\$120	\$80	\$60
		Cushions / Back / TP	\$130	\$90	\$50	\$40
		Arm Panel	\$30	\$30	\$30	\$20
Mini Flange Welt 3/4"		Cushions / Back / TP	\$130	\$90	\$50	\$40
	Body	\$30	\$30	\$30	\$20	

NOTE: COM trims are 50% of the above prices for same option excluding mini ruffle and mini flange welt.

Embroidery Options

NonoMaze	Colors: Porcelain, Onyx	\$200	inside back, outside back, headboard, or throw pillows
NonoLogo	Colors: Porcelain, Onyx	\$200	inside back, outside back, headboard, or throw pillows

HEADBOARD and BED COMPONENTS BED SUPPORT ASSEMBLY INSTRUCTIONS

Headboard All Headboards come standard with a metal mounting plate.
Components Hook plate adaptors are also included for attaching a standard metal bed frame.

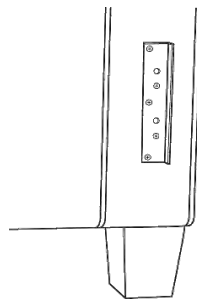

Metal Mounting Plate

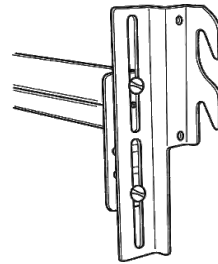

Hook Plate Adaptor

Complete Bed All California king, king, queen, & full complete beds include headboard, sides and
Components foot rails, and adjustable metal slats. Hardware needed for assembly will be included.

BED SUPPORT ASSEMBLY INSTRUCTIONS

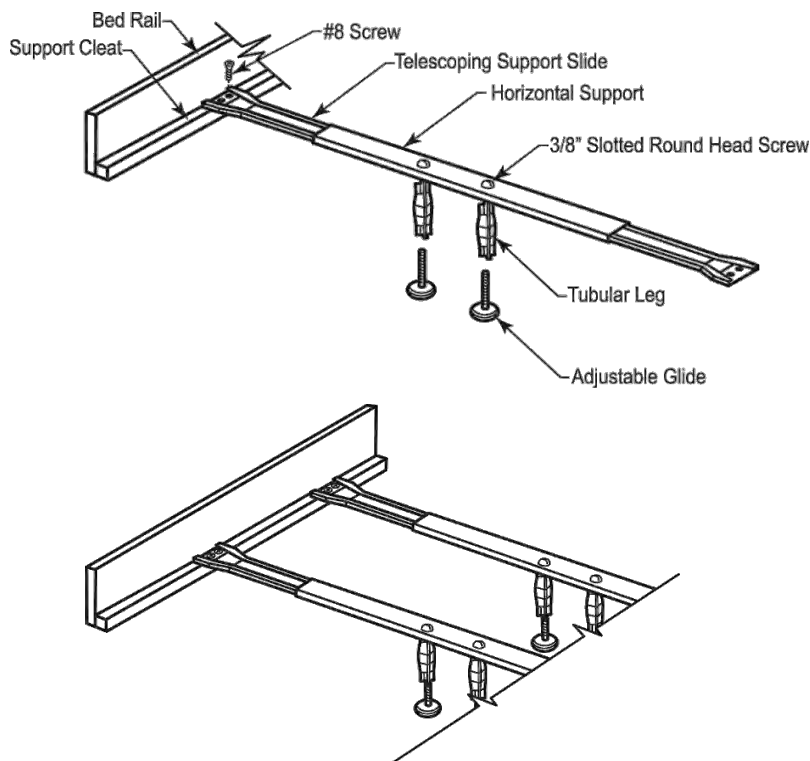

Step 1: Attach tubular leg to horizontal support with 3/8" slotted round head screw

Step 2: Screw the adjustable glide into the tubular leg

Step 3: Extend the two telescoping support slides until the screw tabs are flush with each bed rail and over each support cleat

Step 4: Use #8 screw to attach the support assembly to the support cleats

Step 5: Adjust glide to level the support

SLEEPER MATTRESS OPTIONS CUSTOM LENGTH CUSHION CONFIGURATION OPTIONS

Sleepers Sleepers are standard with a mattress manufactured by Kingsdown® with a 5-year warranty. The appearance and dimensions of the sleeper will vary from the matching non-sleeper frame styles due to the modifications required to accommodate the mattress mechanism. These sleeper mechanisms are a contract series by Leggett and Platt with a three (3) year limited warranty. A double locking TV headrest is a standard feature.

<u>Mattress Sizes</u>		<u>Length When Extended</u>
Queen	60" wide x 75" long x 6" thick	93"
Full	52" wide x 75" long x 6" thick	93"
Twin	32" wide x 72" long x 5" thick	90"

Optional Sleeper Mattress We also offer the **Air Dream®** sofa sleeper system with "air over coil" technology. It is a mattress so comfortable you will want to sleep on it every night. Inflate the cushioning air layer in just 45 seconds with the convenient hand held pump for a bed with comfort and support that rivals premium mattresses. It fits our standard sleeper mechanism in full and queen sizes and gives the same appearance, dimensions, and feel as a standard luxury mattress. The Air Dream® mattress deflates for storage in less than 30 seconds. It will accommodate a standard full or queen size sheet. The Air Dream® comes equipped with a U.L. approved electric pump. This pump plugs into a standard 110V household outlet.

Warranty: The mattress, air bladder, and air bladder valve are warranted to the original owner for three (3) years, and the pump for one (1) year against defective material and workmanship beginning at the date of invoice from us to our retailer.

Full or Queen Size Air Dream® System Upgrade:	\$300.00
Replacement Air Dream® System:	\$500.00

Custom Length **Not all styles can be customized.** Contact Customer Service for custom request approval prior to submitting your order for a final quote.

Allow 1-2 weeks in addition to normal lead time for production.

Due to customization, these pieces are not subject to return or refund.

For sectionals, provide a sketch with dimensions.

Custom lengths may impact cushion configurations.

Following is a general guideline for custom length charges. Note: Pricing may vary based on manufacturing review. If the customization requested requires the addition of another seat or back, the upcharge will be at 50% regardless of inch alteration.

****Choose the style closest to desired length****

When altering up to 15"	Add 35% to total costs
When altering up to 16"- 23.99"	Add 40% to total costs
When altering 24" or more	Add 50% to total costs

Example:

Style Cost	\$ _____
Add Addl Options	\$ _____
Subtotal	= <u>Subtotal x 35%, 40%, or 50%</u>
Custom Length Charge	= <u>SubTotal + Custom Length Charge</u>
Grand Total	\$ _____

Cushion Configuration Options		
Change from Standard	Bench	\$240
Seat and Back Cushion Configuration to:	2 over 2	\$450
	3 over 3	\$450
	2 over 1	\$450
	3 over 1	\$450

SLIPCOVER ONLY PRICING**Slipcover Only Pricing**

Fabric Grade	Loveseat/ Chair & Half/ Chaise/ Settee/ Curve		Chair	Headboard	Dining Chair	Ottoman
	Sofa/ Sleeper/ Daybed					
5	\$900	\$750	\$550	\$330	\$300	\$220
6	\$950	\$780	\$570	\$346	\$306	\$230
7/COM	\$1,002	\$812	\$590	\$362	\$312	\$240
8	\$1,056	\$846	\$610	\$378	\$324	\$260
9	\$1,112	\$882	\$650	\$410	\$336	\$280
10	\$1,170	\$920	\$690	\$442	\$354	\$310
11	\$1,238	\$968	\$730	\$490	\$372	\$340
12	\$1,316	\$1,026	\$790	\$538	\$390	\$370
13	\$1,404	\$1,094	\$850	\$586	\$408	\$400
14	\$1,502	\$1,172	\$910	\$634	\$426	\$430
15	\$1,610	\$1,260	\$970	\$682	\$444	\$460
16	\$1,728	\$1,358	\$1,030	\$730	\$462	\$490
17	\$1,856	\$1,466	\$1,090	\$798	\$480	\$520
18	\$1,994	\$1,584	\$1,150	\$826	\$498	\$550
19	\$2,064	\$1,654	\$1,190	\$866	\$538	\$570
20	\$2,134	\$1,724	\$1,230	\$886	\$578	\$590
Add this amount for each grade > 20	\$70	\$70	\$40	\$20	\$40	\$20

Arm Covers Arm covers are standard on most all fully upholstered styles, excluding styles with exposed wood arms. Additional arm covers are available for \$120 per pair. Arm covers are not available on leather nor slipcovered styles.

Cartoning Cartoning is available for a charge.

Sofa/ Sleeper/ Daybed	Loveseat/ Chair & Half/ Chaise/ Settee/ Headboards	Chair/ Dining Chair	Ottoman
\$90	\$78	\$56	\$56

PHOTOCOPY AND COMPLETE THIS FORM.
ORDER WILL NOT BE PROCESSED UNTIL THIS FORM IS SIGNED AND RETURNED.

C. O. M. Information Form (Not an order)

Dealer Name & Location: _____
 Purchase Order #: _____ Tag for: _____
 Style #: _____
 Fabric Supplier: _____ Yards sent: _____
 Fabric Pattern # & Color: _____
 Fabric Description & Repeat: _____

Has face side of fabric been indicated? _____ yes

Has top of fabric been indicated? _____ yes

Fabric Direction: _____ Apply Up the Bolt  _____ Apply Railroad 

Application Instructions:

Attach Swatch
 Here with Face
 Side Up and Top
 Marked Clearly

FACTORY DISCLAIMER:

We will not be held liable for any instructions not provided.

***Please Note:** If you are sending more than (1) fabric on a roll or in a package, please clearly mark this on the exterior of the roll or package so that we may easily identify your COMs as they are received.

Signature: _____ Date: _____

Ship C. O. M. to:
 Attn: COM Department
 2829 Hwy 70 Southeast
 Hickory, NC 28602

IT IS OUR POLICY NOT TO RETURN EXCESS COM UNLESS REQUESTED ON THE ORIGINAL PO. IF THERE IS EXCESS AND IT IS REQUESTED TO BE RETURNED AFTER THE COMPLETION OF THE ORDER, IT WILL BE SENT AT A CHARGE.

COM GUIDELINES

Customer's Own Material All styles can be covered in a fabric supplied by the customer. The guidelines listed below apply to all COM orders.

- The purchase order is to have: 1) a description of the COM fabric, 2) a small cutting of the COM fabric, and 3) the completed COM Information Form from page 17.

The COM Information Form is not an order. It is used for information purposes only.

- We do not inspect COM fabrics nor take responsibility for quality, flaws, defects, or accuracy of yardage sent. Service issues regarding styles upholstered with defective COM fabrics, or COM fabric that we have partially cut due to flaws or short yardage are not valid.

We reserve the right to refuse a COM order if we determine that the fabric sent is not a suitable upholstery fabric.

- COM shipments are to be clearly identified and shipped prepaid to:

**COM Department
2829 Hwy 70 SE
Hickory, NC 28602**

It is imperative that COM material be identified with dealer name, style number, tag name, purchase order, etc. We will not be responsible for production delays due to improperly identified fabric.

- Unless specific instructions are provided, COM fabrics will be cut and applied by the factory **at our own discretion** without liability for doing so. We reserve the right to use our best judgment in determining if a fabric is to be cut railroad or non-railroad, which side of the COM fabric front or back, and which direction of the COM fabric design is top or bottom.
- Excess COM fabric will not returned unless requested. If the return request is made after the furniture has shipped, your UPS account number must be provided with shipping instructions. If the excess is less than 1 yard, it will not be returned.

COM Yardage Requirements The style-specific COM yardage requirements listed in the price list is for 54" wide fabric with a repeat that is either plain, narrow 2" - 14", or 15" - 27".

For narrow fabric widths, use the following chart for yardage requirements:

<u>Width</u>	<u>Plain</u>	<u>2"- 14" repeat</u>	<u>15"- 27" repeat</u>	<u>28"- 36" repeat</u>
54"	--	25%	35%	45%
48"	15%	30%	40%	50%
36"	50%	65%	70%	75%

PILLOW TREATMENTS

Pillow Treatments

The following decorative pillow treatments are available on any standard or extra pillow for an additional charge:

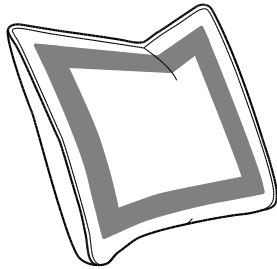

Decorative Band Frame \$75

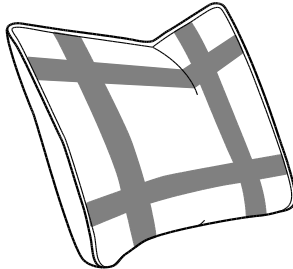

Decorative Band Full Flag \$75

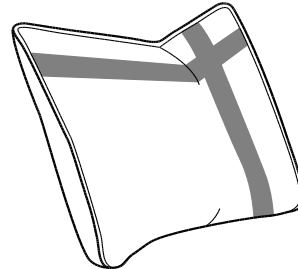

Decorative Band RSF Flag \$75

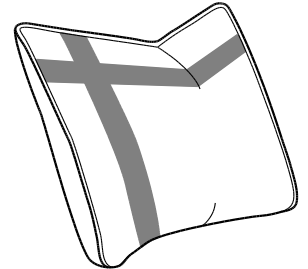

Decorative Band LSF Flag \$75

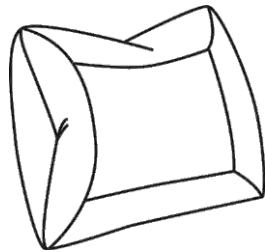

Framed \$51
(one side only)

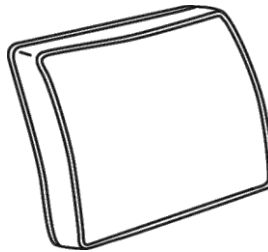

Box Border \$81

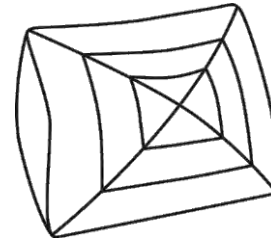

Miter \$48
one side only

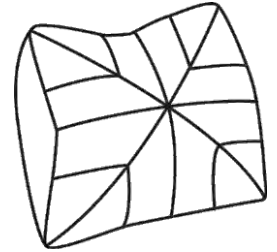

Reverse Miter \$48
one side only

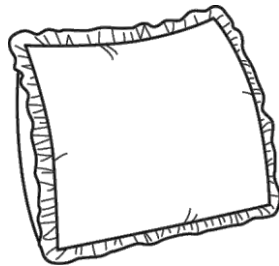

3/4" Mini Ruffle \$48
flange can be contrasted

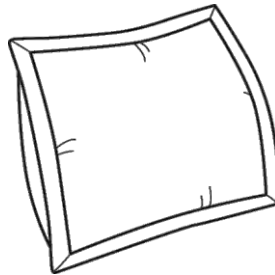

1" Flange \$45
w/mitered Corners

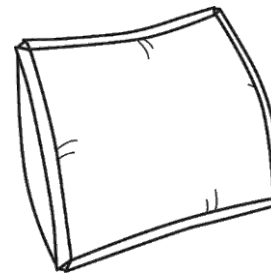

3/4" Mini Flange \$33
pleated corners,
flange can be contrasted

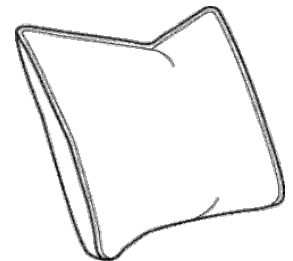

Flat Welt \$33

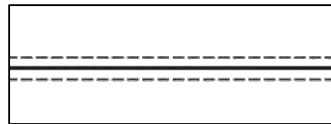

Saddle-Stitch \$39

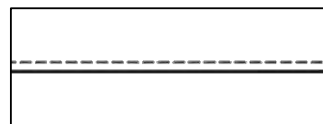

French Seam \$39

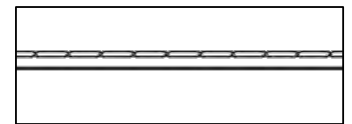

French Seam Rope Stitch \$45

Leather Throw Pillows

STYLE NO.	LTP16	LTP18	LTP20	LTP22	LTP24	LTP109	LTP1034	LTP1422	LTP1623	LRB16
Dims W x H	16 x 16	18 x 18	20 x 20	22 x 22	24 x 24	10 x 19	10 x 34	14 x 22	16 x 23	16" Long
Fill	Legacy Down	Legacy Down	Legacy Down	Legacy Down	Legacy Down	Legacy Down	Legacy Down	Legacy Down	Legacy Down	Fiber
Square Ft	10	12	14	16	17	9	14	12	13	7
Trim Yardage	2.00	2.25	2.50	3.00	3.00	2.00	3.00	2.25	2.50	0.75
7	180	200	220	244	258	172	230	208	218	160
8	190	212	234	260	274	182	244	220	230	166
9	200	224	248	276	290	192	258	232	242	172
10	210	236	262	292	306	202	272	244	254	178
11	220	248	276	308	322	212	286	256	266	184

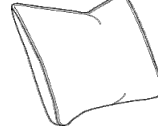
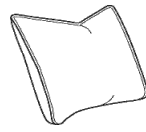

NAME	Throw Pillow	Throw Pillow	Throw Pillow	Throw Pillow	Throw Pillow
STYLE NO.	TP16	TP18	TP20	TP22	TP24
Dimension - W x H	16 x 16	18 x 18	20 x 20	22 x 22	24 x 24
Fill	Legacy Down	Legacy Down	Legacy Down	Legacy Down	Legacy Down
Yardage	0.75	1.00	1.00	1.25	1.25
Trim Yardage	2.00	2.25	2.50	3.00	3.00
TRIM OPTIONS CHARGES					
1" Flange	22	22	22	22	22
1" Flange w/mitered corners	30	30	30	30	30
3/4" Mini Flange w/pleat crns	22	22	22	22	22
Band Crewel	100	100	100	100	100
Band Dot	50	50	50	50	50
Band Fret, Key, & Logo	80	80	80	80	80
Box Border	54	54	54	54	54
Contrast Leather Welt	42	42	42	42	42
Contrast Welt or Bias Welt	10	10	10	10	10
Decorative 1.5" Band Welt	40	40	40	40	40
Decorative Band (any placement)	50	50	50	50	50
Decorative Cord	30	30	30	30	30
Decorative Fringe	40	40	40	40	40
Flat Welt	22	22	22	22	22
Framed	34	34	34	34	34
Fringe Wooly	60	60	60	60	60
Mitered or Reverse Mitered	32	32	32	32	32
Ruffled 3" or Mini Ruffled 3/4"	32	32	32	32	32
Tassel	90	90	90	90	90
Tassel 3"	60	60	60	60	60
Saddlestitch or French Seam	26	26	26	26	26
French Seam Rope Stitch	30	30	30	30	30
Price by 5	104	110	114	120	124
Fabric 6	106	112	116	122	126
Grade 7/COM	108	114	118	124	128
8	110	116	120	126	130
9	112	118	122	128	132
10	114	120	124	130	134
11	116	122	126	132	136
12	118	124	128	134	138
13	120	126	130	136	140
14	122	128	132	138	142
15	124	130	134	140	144
16	126	132	136	142	146
17	128	134	138	144	148
18	130	136	140	146	150
19	134	140	144	150	154
20	138	144	148	154	158
21	142	148	152	158	162
22	146	152	156	162	166
23	150	156	160	166	170
24	154	160	164	170	174
25	158	164	168	174	178
26	162	168	172	178	182
27	166	172	176	182	186
28	170	176	180	186	190
Add this amt for each Grade over 28	4	4	4	4	4

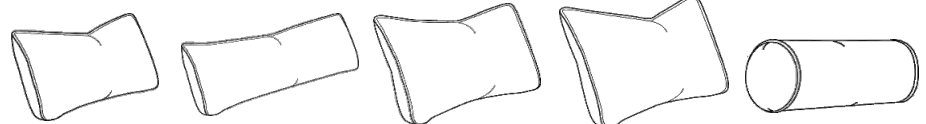

NAME	Kidney Pillow	Kidney Pillow	Kidney Pillow	Bolster	Round Bolster
STYLE NO.	TP109	TP1034	TP1422	TP1623	RB16
Dimension - W x H	10 x 19	10 x 34	14 x 22	16 x 23	16" Long
Fill	Legacy Down	Legacy Down	Legacy Down	Legacy Down	Fiber
Yardage	1.00	1.50	1.25	1.25	1.00
Trim Yardage	2.00	3.00	2.25	2.50	0.75
TRIM OPTIONS CHARGES					
1" Flange	22	22	22	22	22
1" Flange w/mitered corners	30	30	30	30	30
3/4" Mini Flange w/pleat crns	22	22	22	22	22
Band Crewel	100	100	100	100	100
Band Dot	50	50	50	50	50
Band Fret, Key, & Logo	80	80	80	80	80
Box Border	54	54	54	54	54
Contrast Leather Welt	42	42	42	42	42
Contrast Welt or Bias Welt	10	10	10	10	10
Decorative 1.5" Band Welt	40	40	40	40	40
Decorative Band (any placement)	50	50	50	50	50
Decorative Cord	30	30	30	30	30
Decorative Fringe	40	40	40	40	40
Flat Welt	22	22	22	22	22
Framed	34	34	34	34	34
Fringe Wooly	60	60	60	60	60
Mitered or Reverse Mitered	32	32	32	32	32
Ruffled 3" or Mini Ruffled 3/4"	32	32	32	32	32
Tassel	90	90	90	90	90
Tassel 3"	60	60	60	60	60
Saddlestitch or French Seam	26	26	26	26	26
French Seam Rope Stitch	30	30	30	30	30
Price by 5	104	120	114	120	104
Fabric 6	106	122	116	122	106
Grade 7/COM	108	124	118	124	108
8	110	126	120	126	110
9	112	128	122	128	112
10	114	130	124	130	114
11	116	132	126	132	116
12	118	134	128	134	118
13	120	136	130	136	120
14	122	138	132	138	122
15	124	140	134	140	124
16	126	142	136	142	126
17	128	144	138	144	128
18	130	146	140	146	130
19	134	150	144	150	134
20	138	154	148	154	138
21	142	158	152	158	142
22	146	162	156	162	146
23	150	166	160	166	150
24	154	170	164	170	154
25	158	174	168	174	158
26	162	178	172	178	162
27	166	182	176	182	166
28	170	186	180	186	170
Add this amt for each Grade over 28	4	4	4	4	4